

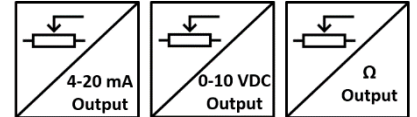

GENERAL FEATURES

- Different stroke (measuring) lengths between 0...5100 mm and 0...11000 mm
- $\pm 0.25\%$ FS linearity
- Potentiometric, 0-10 VDC or 4-20 mA analog output options
- Stainless steel measuring wire
- IP65 protection class
- Compact design
- Easy installation
- 2 m/s maximum speed
- Shock/Vibration resistant
- Aluminum anodized body



AWP 310 series draw wire sensors; consists of a rotary potentiometer which is controlled by stainless steel wire. They make measurement by pulling and rewinding stainless steel wire. Different stroke (measuring) lengths between 0...5100 mm and 0...11000 mm are available. They convert linear motion to potentiometric output.

The “A” series, works with 24VDC supply and gives of 4-20 mA analog output with the help of the converter card.

The “V” series, works with 24VDC supply and gives of 0-10 VDC analog output with the help of the converter card.

Optionally, different non-standard measuring lengths, cable length or socket model can be requested.

TECHNICAL SPECIFICATIONS

*Stroke (measuring) Length	Different measuring lengths between 0...5100 mm and 0...11000 mm	Required Force	12N
*Connection Cable Length	3m (standard), 5m, 10m	*Resistance	5 K Ω (standard), 10 K Ω
*Supply Voltage	‘A’ ve ‘V’ models: 12...30 VDC	Measuring Type	Potentiometric
	Potentiometric output model: 42V max.	Materials	Housing: Aluminum/steel/plastic Measuring Wire: Stainless steel
*Output Signals	Potentiometric 0-10 VDC 4-20 mA	IP Protection Class	IP65
Linearity	$\pm 0.25\%$ FS	Operating Temperature	-25°C ... +85°C
Maximum Speed	2 m/s	Relative Humidity	%95
		Weight	≈ 2700 gr

Note: The technical specifications indicated by (*) vary according to the selected model. The detailed code table is shown on page 3.

ELECTRICAL CONNECTION

Never make or undo electrical connections to the sensor when voltage is applied, otherwise this may result in damage to devices.

0-10V or POTENTIOMETER Connection		
Signal	Cable Color	M12 5 pin male socket
Earth	Silver	Pin 1
+V	Red	Pin 2
0V	Black	Pin 3
0-10V / Pot	Yellow	Pin 4
-	-	Pin 5

4-20 mA Connection		
Signal	Cable Color	M12 5 pin male socket
Earth	Silver	Pin 1
+V	Red	Pin 2
-	-	Pin 3
4-20 mA	Yellow	Pin 4
-	-	Pin 5

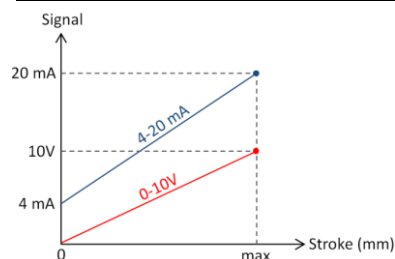
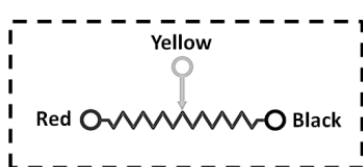
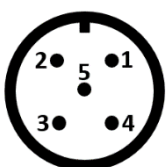

DIMENSIONS

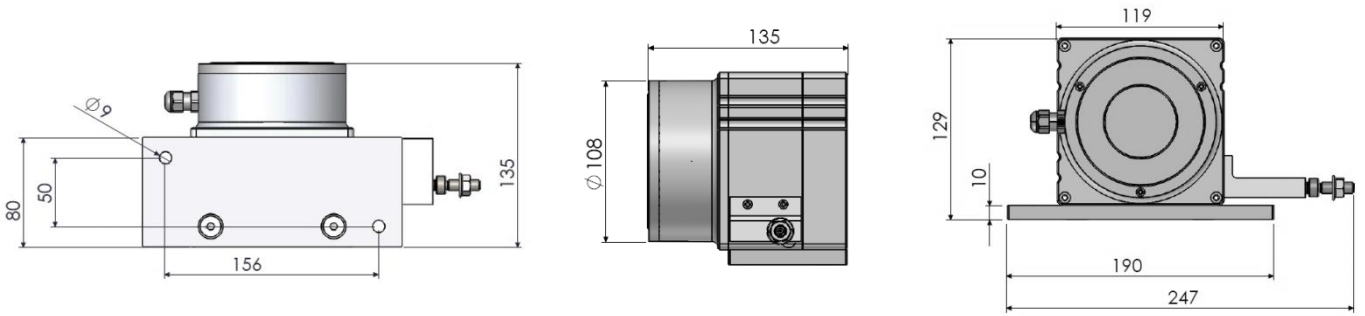

MOUNTING AND WARNINGS

1. Never release the wire after pulling. Otherwise, the coil spring will be damaged.

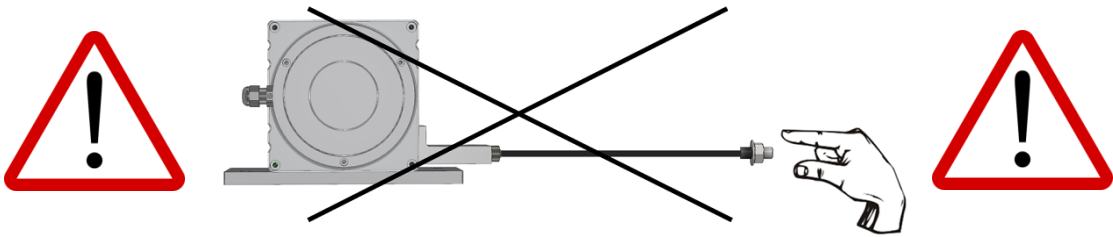

2. Mount the sensor according to the mounting directions shown below.

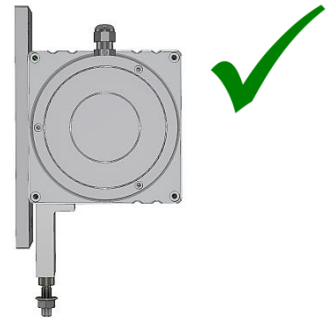
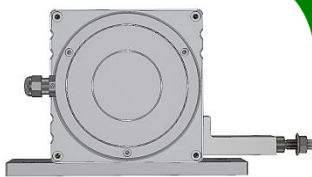
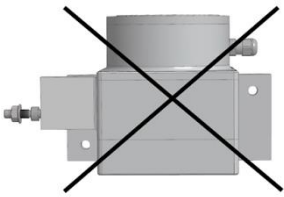

3. If there is a trickle of water (like a rain), the wire outlet must not be a drip of water upstream. If needed please use guide rollers.



4. The wire should not be pulled in angular. If needed, please use guide rollers.

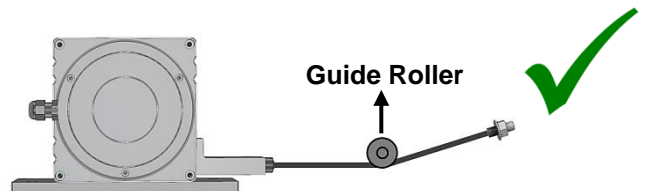
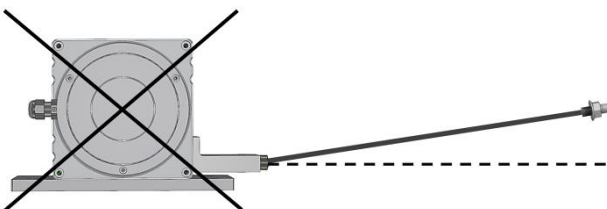

Important Note(!): Failure to comply with these recommendations, the malfunctions that may occur will not be under the warranty.

SAMPLE APPLICATION FIELDS

- Elevators
- Press machines
- Crane systems
- Wood processing machines
- Marble processing machines
- Storage positioning
- Dam protections
- Sluice gate control
- Air compressors
- Glass processing machines
- Lifting platforms
- Applications in medical technologies (operating table etc.)
- Forklifts
- Screw machines
- Paper machines
- Sewing machines
- Hydraulic machines
- Sheet metal machines
- Printing machines
- Horizontal control equipments
- Construction machines
- Industrial robots
- Injection machines
- X-Y axis displacement
- Liquid level measurements and position control

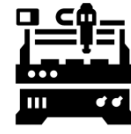
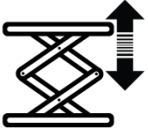

PRODUCT CODE

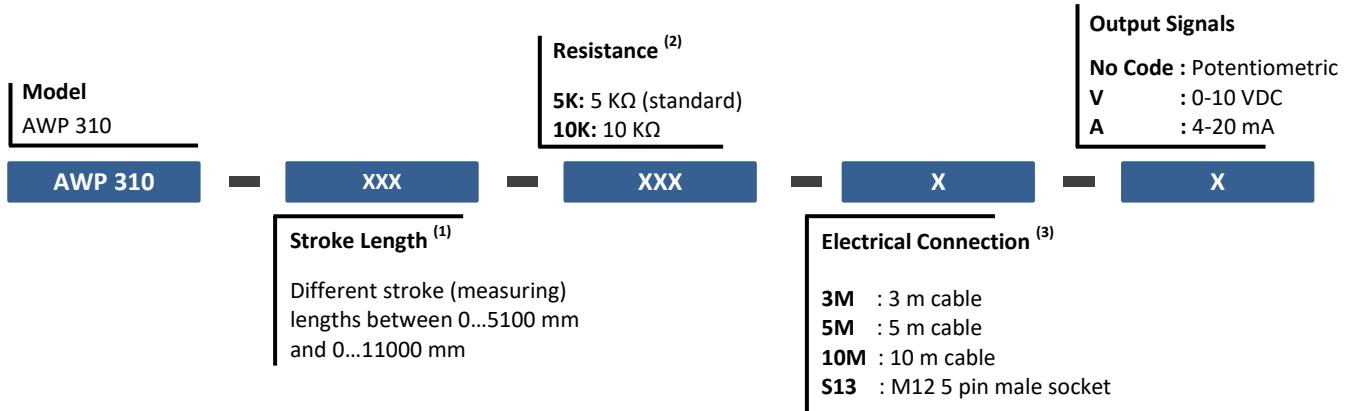

(1) For other (special production) stroke lengths, please contact us.

(2) For other resistance options, please contact us.

(3) Product can be requested with cable or socket. Please contact us for other cable length and socket model requests.

Sample Code 1: AWP-310-6000-5K-S13-A

AWP 310 series, 6000 mm stroke, 5K resistance, 1 pcs M12 5 pin male socket, current output

Sample Code 2: AWP-310-6000-5K-3M-V

AWP 310 series, 6000 mm stroke, 5K resistance, 3 meters cable output, volt output

Atek Sensor Technologies



Tuzla KOSB Organize Sanayi Bolgesi Melek Aras Bulvari, No:67 34956 Tuzla-İstanbul / TURKEY



Tel: +90 216 399 44 04



Fax: +90 216 399 44 02



www.ateksensor.com



info@ateksensor.com