

# MK

## MAGNETIC ABSOLUTE LINEAR ENCODER



Non contact absolute magnetic linear encoder MK has measuring length up to 30 m.

The encoder is used to convert linear displacements of key machine components into electrical signals containing information about components absolute position.

Encoder consists of metal based magnetic band MP, reading head and protective steel cover CV. Encoder also could be supplied with protective aluminium support SP (instead protective cover CV), which is mounted on machine for magnetic band protection.



The encoder has two versions of serial interface SSI or BiSS C. On option third encoder version is available: with 2 analog sinusoidal signals with phase shift 90° C and amplitude approx. 1Vpp .

### MECHANICAL DATA

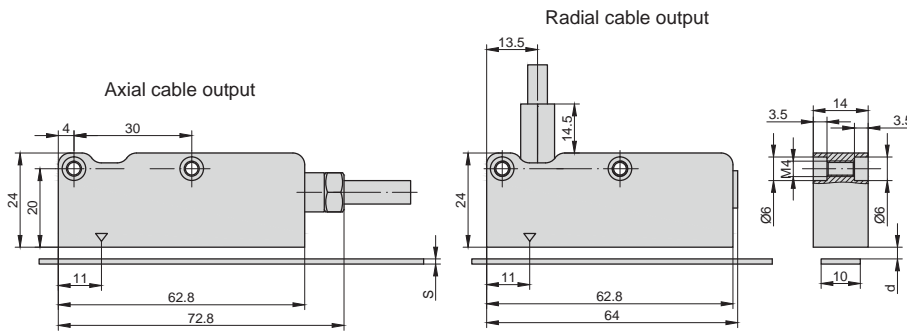

Value, mm	MP200A	MP200A +CV	MP200A +SP
s	1.3	1.6	2.1
d	0.3 ÷ 1.0	0.7 MAX	0.2 MAX

s - thickness  
d - distance between reading head and magnetic band MP or protective cover CV (protective support SP)

Permissible tolerances for reading head mounting

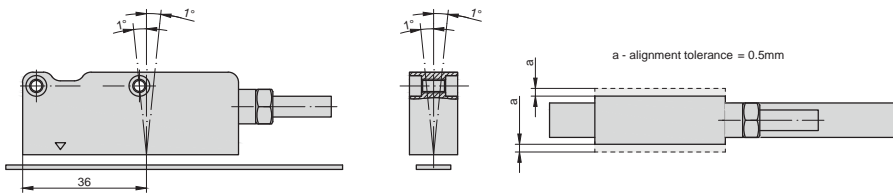

### MK PARAMETERS

Pole pitch	2+2 mm	Protection (EN 60529)	IP67
Measuring length (ML)	up to 30 m	Operating temperature	0...+50 °C
Incremental signal	since wave 1Vpp (optional)	Storage temperature	-20...+70 °C
Resolution 1Vpp	up to 1µm (depending on CNC division factor)	Permissible humidity	100%
Repeatability	± 1 increment	Permissible vibration (55...2000 Hz)	200 m/s <sup>2</sup>
Signal period	2 mm	Permissible shock (11 ms)	1000 m/s <sup>2</sup>
Serial interface	SSI or BiSS	Weight of reading head	80 g
Resolution absolute position	500, 100, 50, 10, 5, 1 µm	Electrical protections	from inversion of power supply polarity and from short circuit on output port
Accuracy	± 15 µm	Standard cable length / max. cable length	2.0 / 25.0 m (100 m if power supply is 5V)
Max. traversing speed	300 m/min		
Power supply	(5 ... 28 V) DC ± 5%		
Current consumption with load	150 mA max. (with R=120Ω)		

## OUTPUT SIGNALS

<b>Interface</b>	SSI Binary - Gray	BiSS C unidirectional
<b>Signals level</b>	EIA RS 485	EIA RS 485
<b>Clock frequency</b>	0.1 ÷ 1.2 MHz	0.1 ÷ 4 MHz
<b>n</b>	Position bit	26 + 2 + bit
<b>Tc</b>	12 ÷ 65 µs	12 ÷ 20 µs

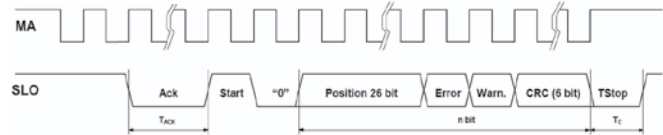
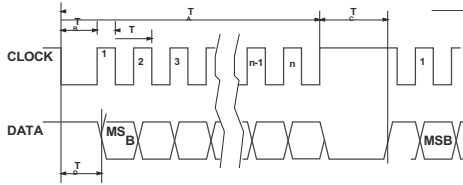

## CABLE

### Cable for serial output:

- 6-wire shielded cable,  $\varnothing=7$  mm, PVC external sheath, with low friction coefficient, oil-resistant, suitable for continuous movements
- conductors section: supply 0.25 mm<sup>2</sup>, signals 0.25 mm<sup>2</sup>
- cable's bending radius should not be lower than 35 mm.

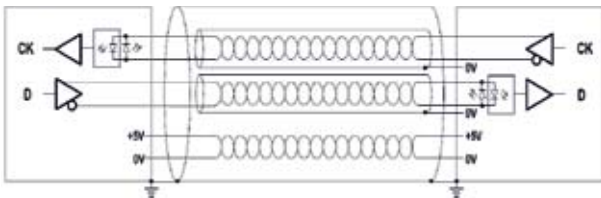

NOTE: Encoder is supplied with flexible cable, that consists of twisted pair of wires (for informational signals SSI-BiSS).

### Cable for analog output + serial output:

- 10-wire shielded cable,  $\varnothing = 7.1$  mm, PUR external sheath. Inside the cable, a further shield for the twisted pair of the digital signals (SSI-BiSS) is presented.
  - conductors section: supply 0.35 mm<sup>2</sup>, signals 0.10 mm<sup>2</sup>
  - cable's bending radius should not be lower than 45 mm.
- In case of cable extension, it is necessary to guarantee:
- electrical connection between the body of the connectors and the cables shield;
  - minimum power supply voltage of 5 V to the head.

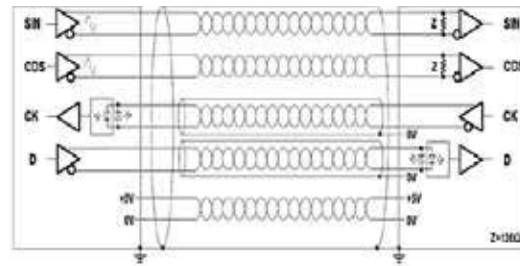

## PROTECTIVE BAND CV

Stainless steel cover CV (width 10 mm, thickness 0,3 mm) for magnetic band MP protection is glued on magnetic band.

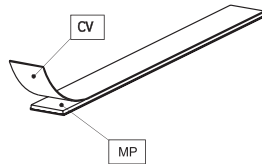

## PROTECTIVE SUPPORT SP

Aluminium protective support SP for magnetic band MP protection. Fixed on machine surface and holds magnetic band. It is not possible to use the support SP if the magnetic band is already covered by stainless steel band CV.

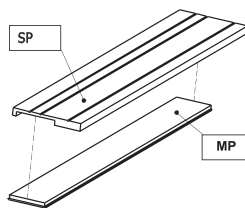

## MAGNETIC BAND MP200A

Pole pitch	2+ 2 mm
Accuracy (at 20 °C)	±20; ±80 µm/m
Width	10 mm
Thickness	1,3 mm
Length	30 m max.
Bend radius	80 mm min.
Weight of magnetic band	65 g/m
Weight of protective cover	25 g/m
Operating temperature	0...+70 °C
Storage temperature	20...+80 °C

## ORDER FORM

<b>MK</b>	-	XXXX	-	XX	-	X	-	XX / XX	-	XX / XX	-	XX / XX			
<b>ABSOLUTE RESOLUTION:</b>	F10 - 1µm F50 - 5µm F100 - 10µm F500 - 50µm F1000 - 100µm F5000 - 500µm	<b>OUTPUT SIGNALS:</b>	AS0 - SSI programmable S1 - SSI binary S2 - SSI binary+even parity S3 - SSI binary+odd parity S4 - SSI binary+error S5 - SSI binary+even parity+error S6 - SSI binary+odd parity+error S7 - SSI Gray B1 - BiSS binary	<b>INCREMENTAL SIGNALS:</b>	W - without incremental signals V - 1Vpp	<b>MAGNETIC BAND LENGTH:</b>	MP200A/01 - 1m MP200A/02 - 2m MP200A/03 - 3m ... MP200A/20 - 20m	<b>PROTECTIVE STEEL COVER LENGTH:</b>	CV/01 - 1m CV/02 - 2m CV/03 - 3m ...	<b>OR ALUMINIUM PROTECTIVE SUPPORT:</b>	SP/01 - 1m SP/02 - 2m SP/03 - 3m ...	<b>CABLE LENGTH AND OUTPUT:</b>	A01-1m axial A02-2m ... R01-1m radial R02-2m ...	<b>CONNECTOR TYPE:</b>	W - without connector B12 - round, 12 pins C12 - round, 12 pins D9 - flat, 9 pins D15 - flat, 15 pins

ORDER EXAMPLE:

1) MK-F10-S2-V-MP200A/02- SP/02-A02/C12