

MLC-520

“Magnetic Non-Contact Measurement,
For Press Brake and Bending
Machines”

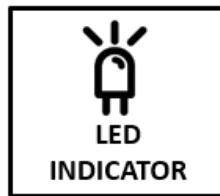
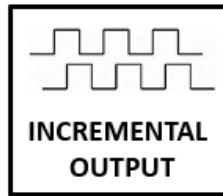
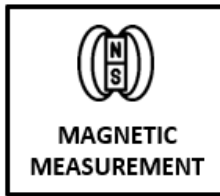

- Magnetic non-contact measurement
- Different measuring lengths between 50 ... 2000 mm
- Adjustable Z reference points
- 5µm, 10µm, 25µm, 50 µm, 62.5µm, 100µm resolution options
- Incremental encoder output: A, B, Z, /A, /B, /Z
- Status LEDs
- Versatile mounting possibilities
- Shock and vibrations resistance
- Resistant to dust, oil and moisture
- Robust aluminum body
- IP67 protection
- Compatible with Delem, Cybelec and ESA

MECHANICAL AND ENVIRONMENTAL DATA

Measuring Length (stroke)	Different options between 50 ... 2000 mm (See. page 2: Measuring lengths)
Maximum Speed	3 m/s
Protection	IP67
Mechanical Fixing	End caps on the both side
Operating Temperature	-25°C...+85°C
Storage Temperature	-30°C...+90°C
Material	Sensor: Anodized aluminum and delrin
	Profile: Anodized aluminum

DIMENSIONS (mm)

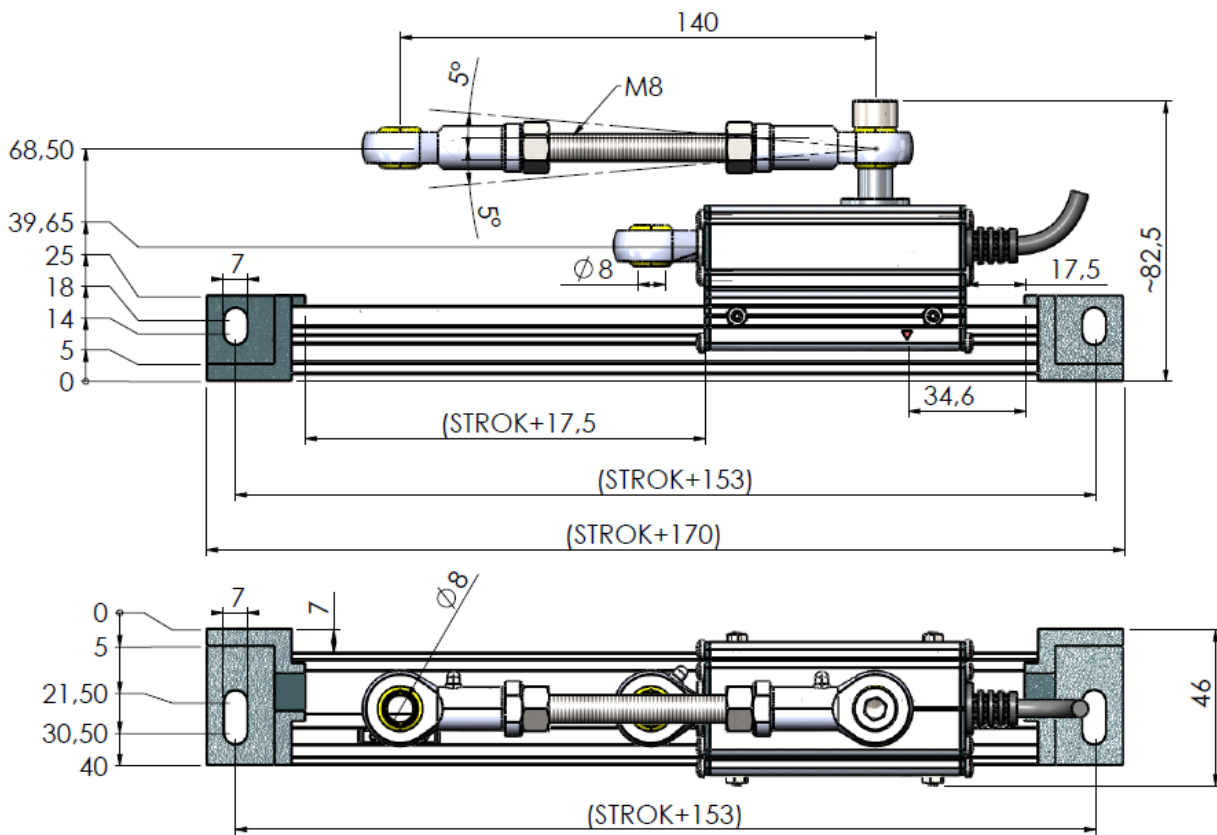

Standard Measuring Lengths (Stroke) (mm)

50	100	150	170	200	220	250	270	300	320
350	370	400	420	450	470	500	520	570	620
670	700	750	800	900	1000	1250	1500	1800	2000

*Optional other lengths

ELECTRICAL DATA

Measuring Type	Magnetic, non-contact				
Measuring Length (stroke)	Different options between 50 ... 2000 mm (See. page 2: Measuring lengths)				
Resolution	5µm, 10µm, 25µm, 50 µm, 62.5µm, 100µm				
Accuracy	± 35 µm/m				
Repeatability	± 1 Pulse				
Magnetic Tape	B2, B5				
Supply and Output Type		PP	TTL	HTL	HPL
	Supply	10...30 VDC	5 VDC	10...30 VDC	5...30 VDC
	Output	10...30 VDC Pushpull	5 VDC TTL Linedriver	5 VDC TTL Linedriver	5...30 VDC Pushpull
Output Signals	A, /A, B, /B, Z, /Z				
Current Consumption	40 mA /channel max.				
Electrical Connection	D-Sub 9 pin connector, 5 or 8 x 0,14 mm ² shielded cable				

LED FUNCTION

Led Color	Description
Off	Sensor is not working – No supply voltage
Yellow	It is active at the rising edges of the A signal
Blue	It is active at the rising edges of the B signal
Red	It is active at the rising edges of the Z signal

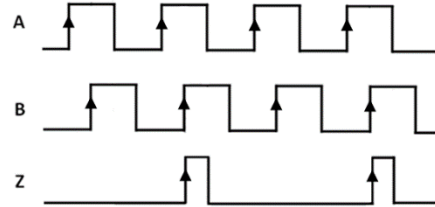

ELECTRICAL CONNECTIONS

SIGNAL	CABLE COLOR	D-SUB 9 PIN / CONNECTOR PIN NO
A	Yellow	1
/B	White	2
+V	Red	3
0V	Black	4
/A	Blue	5
B	Green	6
/Z	Grey	7
Z	Pink	8
-	Shield	9

- B2 Tape -

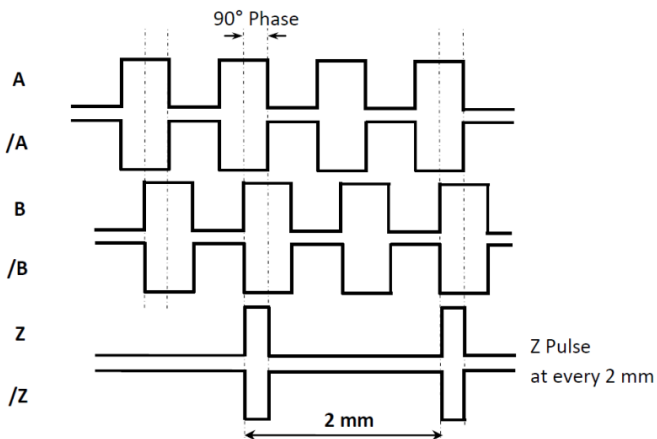

- B5 Tape -

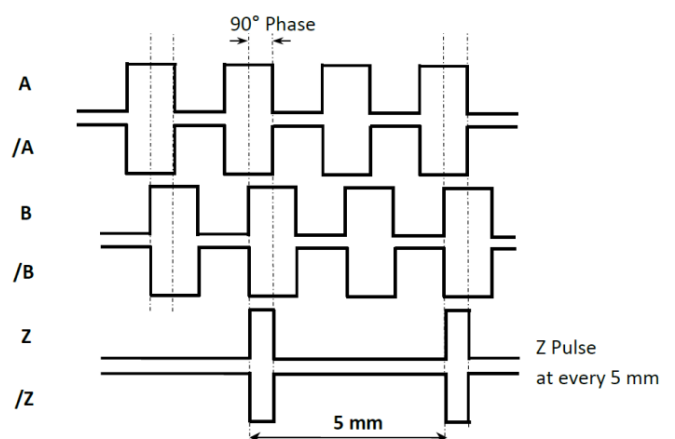

ORDER CODE

Model	Resolution			Signal Output Type			Cable Type					
MLC-520	-	XX	-	XX	-	XXX	-	X	-	XXX		
	Magnetic Tape B2 B5			Supply and Output PP : 10...30 VDC Supply : 10...30VDC Output TTL : 5 VDC Supply : 5 VDC TTL RS422 Line Driver Output HTL : 10...30 VDC Supply : 5 VDC TTL RS422 Line Driver Output HPL : 5...30 VDC Supply : 5...30 VDC Push-Pull Output			Cable Length 3M : 3 meters 3.5M : 3,5 meters 4M : 4 meters 5M : 5 meters 6M : 6 meters 7M : 7 meters 8M : 8 meters 9M : 9 meters 10M : 10 meters 15M : 15 meters * Please ask for other options			Measuring Lengths (Stroke) Different options from 50 mm to 2000 mm (See. pg2: Measuring lengths)		
	Resolution 05 : 5µm 10 : 10µm 25 : 25µm 50 : 50µm 62 : 62,5µm 100 :100µm			Signal Output Type 2 : A, B 3 : A, B, Z 4 : A, /A, B, /B 6 : A, /A, B, /B, Z, /Z Standard: Z reference signal at every 5 mm for B5 Tape or every 2 mm for B2 tape			Cable Type C : Pure Cable S : Shielded Spiral					